



# A Tradition of Quality

## WE'RE THE CALM BEFORE - AND AFTER - THE STORM

*It's unpredictable. It's inconvenient.*

*And yes, it can show up at your doorstep unannounced . . .*

*. . . The Weather.*

That's why we've designed your windows with two very important things in mind: accenting your home and protecting it from harsh weather conditions.

At International Window, we can't predict the weather. But we can predict where it will stay - outside your home. We've spent over five decades perfecting our lines of aluminum and vinyl windows and doors. In fact, as one of the early pioneers of aluminum windows, we're pleased to offer you one of the largest selections of aluminum windows available on the market today.



## Features

At International Window, quality is our trademark. That's why we leave nothing to chance. We use premium quality aluminum extrusions in all of our windows and patio doors, offered in clear or bronze anodized and white or beige paint. Then each product undergoes rigorous testing to ensure its adaptability to changing climatic conditions. By using state-of-the-art technology, we are able to consistently manufacture top quality windows and doors.

A lot of companies talk about customer service. At International Window, we embrace it – by treating each customer with respect and dignity. That means keeping our promises, standing behind our products, shipping on time and listening to what our customers have to say. Our dedicated sales staff is available to service your needs. Frankly, we value you as a customer. We appreciate your business. We'll do what it takes to make you happy. It's that simple.



# ALUMINUM

## Table of Contents

### RESIDENTIAL WINDOW SERIES

W  
I  
N  
D  
O  
W  
S

#### **SERIES 6200**

*Single Hung Window* Page 4

*Full, Half, Quarter Circle Windows*

*Picture Windows*

*Horizontal Sliding Window* Page 5

*Casement & Awning Windows*

*Window Configurations* Page 6

*Performance Matrix* Page 8

### RESIDENTIAL DOOR SERIES

D  
O  
O  
R  
S

#### **SERIES 6900**

*Imperial Patio Door* Page 9

*Door Configurations* Page 10

*Performance Matrix*

*Door Frame Profiles*

### COMMERCIAL PRODUCTS

W  
I  
N  
D  
O  
W  
S

#### **SERIES 6200**

*Commercial Windows* Page 11

### WARRANTY INFORMATION

W  
I  
N  
D  
O  
W  
S

*Warranty Page* Page 11

# DOORS

## SERIES 6200

**QUALITY OR PRICE.** People think it's a compromise. You know, one or the other. Well, we don't believe you should have to sacrifice anything. So, we designed the 6200 Imperial Series - a competitively priced aluminum window that literally redefines quality. We've engineered the 6200 Series to reflect a product that is secure, strong and remarkably durable. The Series is available in single hung, horizontal slide, casement, bay, bow and picture window configurations. Our standard dual glazed configuration gives you additional thermal protection, while reducing unwanted outdoor noise.

## SINGLE HUNG



**THE SINGLE HUNG WINDOW** is the premier product in the Imperial Series. This window features a fixed panel and a lower sash panel that gently glides to a ventilating position. The sash panel tilts inward, making exterior glass cleaning a breeze. For your convenience, the design incorporates a simple-to-use latch and lock mechanism.

*Shown with optional marginal v-groove glass*



Picture



Full, Half, Quarter Circle Picture

### ALSO AVAILABLE IN THE 6200 SERIES:

There's nothing like a room with a view. The Imperial Series **PICTURE WINDOW** allows in bright sunlight, while providing your home with its own unique architectural accent. It has been engineered to reflect a product that is secure, strong and remarkably durable. For a look that's absolutely picture perfect, select one of our charming geometric patterns to highlight the best features of your home.

## FEATURES

### SINGLE HUNG CORNER SECTION



- 2 5/8" Frame Depth
- Tilt-in Sashes
- 3/4" Dual Glazing
- Marine Glazed
- Clean and Even Sight Lines
- Sloped Sill with Weepholes

#### Additional Features

- Spring Loaded Balance
- Built-in Security Night Lock

## SECURITY



### DESIGNER SERIES RECESSED LATCH & LOCK



**SERIES 6200**

# WINDOWS

## HORIZONTAL SLIDING

### FEATURES

#### HORIZONTAL SLIDING CORNER SECTION



- 2 5/8" Frame Depth
- 3/4" Dual Glazing
- Clean and Even Sight Lines
- Marine Glazed

#### Additional Features

- Anti-Lift Sash Blocks
- Adjustable Delrin Rollers in Extruded Housing (pictured below)
- Built-in Security Night Lock



**NIGHT LOCK**



*Shown with optional grid pattern*

**THE HORIZONTAL SLIDING WINDOW** has been a longtime staple of contractors and builders. This window accents virtually every room in the house. The Delrin rollers ensure smooth operation. Our safety features include a simplified latch and lock system and a secondary NightLock, which enables the window to remain in a locked position while providing 2" of ventilation.













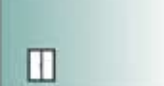







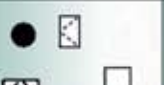





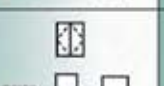

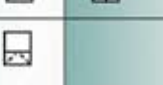



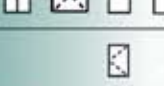
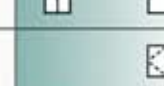
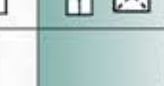









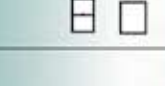





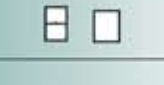

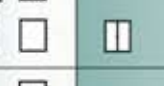

#### ALSO AVAILABLE IN THE 6200 SERIES:

Add personality to your home with the Imperial Series **CASEMENT AND AWNING WINDOWS**. Using euro-style operator system to open and close the window, casement windows open from the side, while awning windows open from the horizontal sill position providing ventilation.



**Casement & Awning**

# SERIES 6200 CONFIGURATIONS

NOMINAL DIMENSION			1-6	2-0	2-6	3-0	3-6
ROUGH OPENING			18	24	30	36	42
NFD			17 <sup>3</sup> / <sub>8</sub>	23 <sup>3</sup> / <sub>8</sub>	29 <sup>3</sup> / <sub>8</sub>	35 <sup>3</sup> / <sub>8</sub>	41 <sup>3</sup> / <sub>8</sub>
1-0	12	11 <sup>3</sup> / <sub>8</sub>					
1-6	18	17 <sup>3</sup> / <sub>8</sub>					
2-0	24	23 <sup>3</sup> / <sub>8</sub>					
2-6	30	29 <sup>3</sup> / <sub>8</sub>					
3-0	36	35 <sup>3</sup> / <sub>8</sub>					
3-6	42	41 <sup>3</sup> / <sub>8</sub>					
4-0	48	47 <sup>3</sup> / <sub>8</sub>					
4-6	54	53 <sup>3</sup> / <sub>8</sub>					
5-0	60	59 <sup>3</sup> / <sub>8</sub>					
6-0	72	71 <sup>3</sup> / <sub>8</sub>					
7-0	84	83 <sup>3</sup> / <sub>8</sub>					
8-0	96	95 <sup>3</sup> / <sub>8</sub>					

STANDARD SIZES SHOWN. NON-STANDARD SIZES AVAILABLE UPON REQUEST.

# WINDOWS

4-0	5-0	6-0	7-0	8-0	10-0
48	60	72	84	96	120
47 <sup>3</sup> / <sub>8</sub>	59 <sup>3</sup> / <sub>8</sub>	71 <sup>3</sup> / <sub>8</sub>	83 <sup>3</sup> / <sub>8</sub>	95 <sup>3</sup> / <sub>8</sub>	119 <sup>3</sup> / <sub>8</sub>

NET FRAME DIMENSIONS SHOWN ARE FOR NAIL-ON FRAMES ONLY. BLOCK WINDOW NET FRAME DIMENSIONS FOR HORIZONTAL SLIDE, SINGLE HUNG AND FIXED WINDOWS.

- = HORIZONTAL SLIDE
- = FIXED
- = HEAVY DUTY FIXED
- = SINGLE HUNG
- = 1/3 VENT SINGLE HUNG
- = AWNING
- = FIXED WITH AWNING
- = CASEMENT
- = DOUBLE CASEMENT
- = CASEMENT/FIXED
- = UBC EGRESS

DIVISIONS	WIDTH	HEIGHT
IWC - Call office	NOMINAL - 1/8"	NOMINAL - 1/8"
IWC - Call office	NOMINAL - 1/4"	NOMINAL - 1/8"



# CHART

**SERIES 6200**

## WINDOWS PERFORMANCE MATRIX

DESCRIPTION	AAMA RATING (1)	STRUCTURALLY TESTED (MPH)(2)	FORCED ENTRY TESTED(3)	U-FACTOR RANGE(4)	SHGC RANGE(5)	Vt RANGE(6)	STC TESTED RANGE(7)
HORIZONTAL SLIDER	HS-R20	108	PASSED	.54 -.77	.24 -.70	.07 -.70	29 - 33
SINGLE HUNG	SH-R20	108	PASSED	.53 -.77	.24 -.69	.07 -.69	30 - 33
PICTURE WINDOW	F-R20	108	PASSED	.37 -.63	.15 -.72	.13 -.75	31
CASEMENT	C-C30	108	PASSED	.49 -.69	.15 -.64	.12 -.64	30 - 35
AWNING	A-R20	108	PASSED	.49 -.69	.15 -.64	.12 -.64	N/A

1. Tested in accordance to AAMA 101/I.S.2-97 specifications.
2. Static pressure and air velocity relationship expressed mathematically by the formula:  $P = .00256V^2$
3. Forced entry resistance tested in accordance to CAWM 301-90.
4. U-Factor determined in accordance to NFRC-100.
5. Solar heat gain coefficient certified in accordance to NFRC-200.
7. Visible light transmittance certified in accordance to NFRC-200.
8. Sound transmission class determined using ASTM-413.

# FRAMES

## WINDOWS FRAME PROFILES

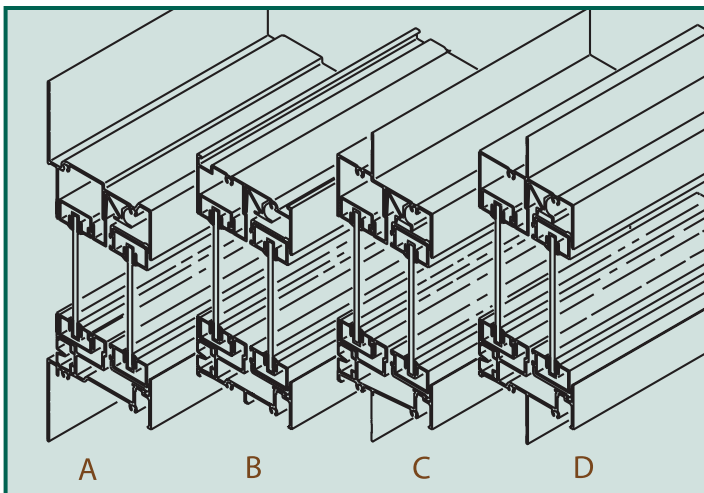

We offer several frame options that fit your individual needs. We recommend the flush fin frame when replacing existing windows. The block frame is appropriate for either replacement or new construction applications. The nail-on frame is typically used for new construction projects.

- A. **FLUSH FIN**
- B. **BLOCK FRAME**
- C. **1" NAIL-ON FRAME\***
- D. **1 3/8" NAIL-ON FRAME**

\*AVAILABLE ONLY IN SOUTHERN CALIFORNIA



**SERIES 6900**

# DOORS



## IMPERIAL PATIO DOOR

This inside slide door combines a slim design with a heavy-duty aluminum extrusion, resulting in a strong, rigid patio door that meets minimum security requirements. The 6900 SERIES also features a NightLock, which enables the door to maintain a secure, locked position while allowing 2" of ventilation. Available in nail-on frame and retrofit configurations.



**STANDARD HANDLE**

DOOR SERIES	GLASS THICKNESS	FRAME WIDTH	FRAME TYPE
6920	3/4" DUAL GLAZED,	5 1/4" FRAME,	1" FIN OFF-SET
6960	3/4" DUAL GLAZED,	5 5/8" FRAME,	FLUSH FIN
6980	3/4" DUAL GLAZED,	3 3/4" FRAME,	BLOCK FRAME

**HORIZONTAL SECTION - 6920 SERIES**

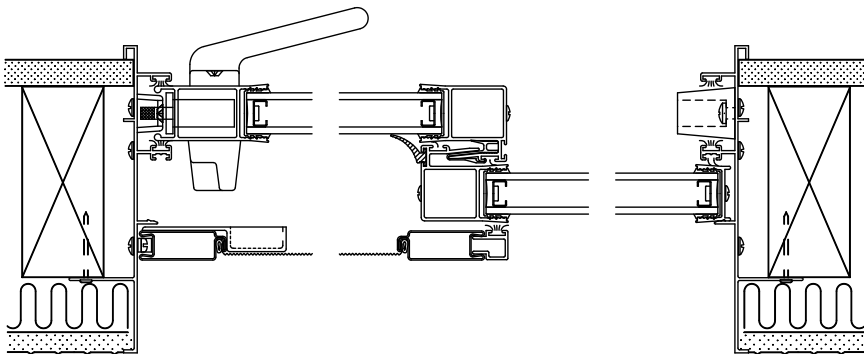

**SHOWING 5 1/4" FRAME  
DUAL GLAZED**

**HORIZONTAL SECTION - 6980 SERIES**

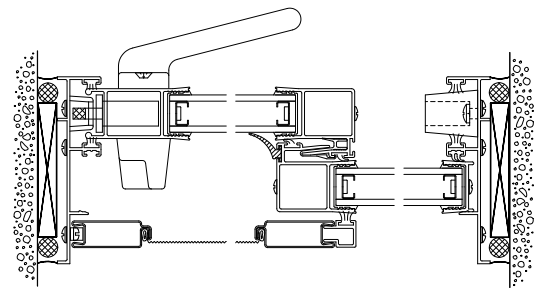

**SHOWING 3 3/4" FRAME  
DUAL GLAZED**

# SERIES 6900

## STANDARD DOOR SIZES

6900 DOOR GLASS SIZE			X O	O X	O X O	O O X	X O O	O X X O	X O O X					
NOMINAL DIMENSION			5-0	6-0	8-0	7-6	9-0	12-0	10-0	12-0	16-0	10-0	12-0	16-0
	ROUGH OPENING		60"	72"	96"	88 <sup>5</sup> / <sub>8</sub> "	106 <sup>5</sup> / <sub>8</sub> "	142 <sup>5</sup> / <sub>8</sub> "	118 <sup>7</sup> / <sub>8</sub> "	142 <sup>7</sup> / <sub>8</sub> "	190 <sup>7</sup> / <sub>8</sub> "	119 <sup>3</sup> / <sub>8</sub> "	143 <sup>3</sup> / <sub>8</sub> "	191 <sup>3</sup> / <sub>8</sub> "
		NFD	59 <sup>1</sup> / <sub>2</sub> "	71 <sup>1</sup> / <sub>2</sub> "	95 <sup>1</sup> / <sub>2</sub> "	88 <sup>1</sup> / <sub>8</sub> "	106 <sup>1</sup> / <sub>8</sub> "	142 <sup>1</sup> / <sub>8</sub> "	118 <sup>3</sup> / <sub>8</sub> "	142 <sup>3</sup> / <sub>8</sub> "	190 <sup>3</sup> / <sub>8</sub> "	118 <sup>7</sup> / <sub>8</sub> "	142 <sup>7</sup> / <sub>8</sub> "	190 <sup>7</sup> / <sub>8</sub> "
6-8'	80"	79 <sup>1</sup> / <sub>2</sub> "	28 x 75	34 x 75	46 x 75	28 x 75	34 x 75	46 x 75	28 x 75	34 x 75	46 x 75	28 x 75	34 x 75	46 x 75
8-0'	96"	95 <sup>1</sup> / <sub>2</sub> "	28 x 91	34 x 91	46 x 91	28 x 91	34 x 91	46 x 91	28 x 91	34 x 91	46 x 91	28 x 91	34 x 91	46 x 91

## DOORS PERFORMANCE MATRIX

DESCRIPTION	AAMA RATING <sup>(1)</sup>	STRUCTURALLY TESTED (MPH) <sup>(2)</sup>	FORCED ENTRY TESTED <sup>(3)</sup>	U-FACTOR RANGE <sup>(4)</sup>	SHGC RANGE <sup>(5)</sup>	Vt RANGE <sup>(6)</sup>	STC TESTED RANGE <sup>(7)</sup>
6900 SLIDING DOOR	SGD-R20	108	PASSED	.50 -.76	.29 -.70	.16 -.70	26 -27

1. Tested in accordance to AAMA 101/I.S.2-97 specifications.
2. Static pressure and air velocity relationship expressed mathematically by the formula:  $P = .00256V^2$
3. Forced entry resistance tested in accordance to AAMA Grade 10.
4. U-Factor determined in accordance to NFRC-100.
5. Solar heat gain coefficient certified in accordance to NFRC-200.
6. Visible light transmission certified in accordance to NFRC-200.
7. Sound transmission class determined using ASTM-413.

## DOORS FRAME PROFILES

### 6900 Series Patio Doors

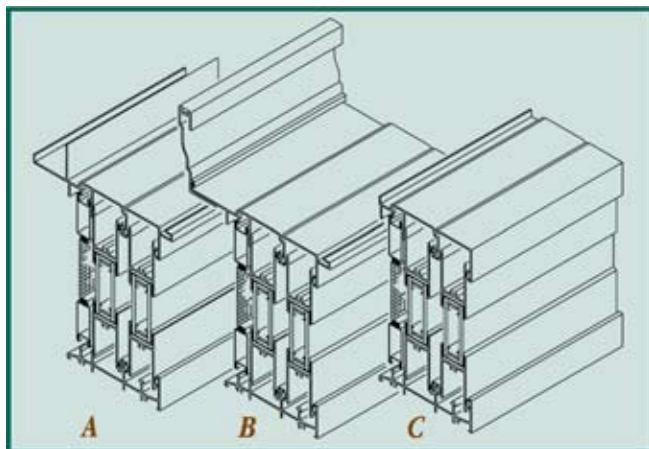

We offer several frame options that fit your individual needs. We recommend the flush fin frame when replacing existing windows. The block frame is appropriate for either replacement or new construction applications. The nail-on frame is typically used for new construction projects.

- A. 5 1/4" NAIL-ON FRAME
- B. 5 5/8" FLUSH FIN
- C. 3 3/4" BLOCK FRAME

# WINDOWS

**SERIES 6200 COMMERCIAL WINDOW**



**Horizontal Sliding**



**Single Hung**



**Picture**



**Casement & Awning**

The *Commercial 6200 Series* aluminum window line may be used for many different types of buildings — from apartment building to office complexes. Whether you need install new or replacement windows, the Commercial 6200 Series offers the type of solid aluminum construction required to meet the demands of a variety of structural conditions. Available in Single Hung, Horizontal Sliding, Picture, Casement and Awning.

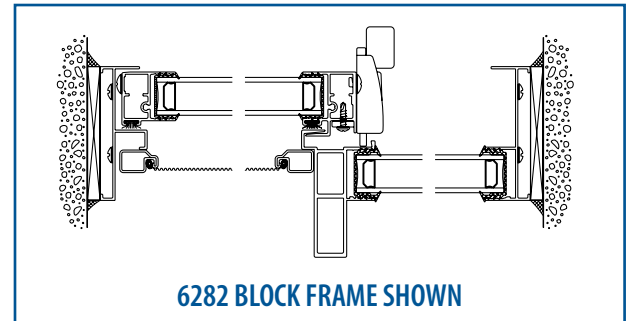

**6282 BLOCK FRAME SHOWN**

**High Sill and Heavier Mullion Grant the Commercial Rating for this Attractive Window Series.**

## *About Our Warranty*

At International Window, quality products are our trademark, which is why we have left nothing to chance. Our Lifetime Warranty program is to help assure you, our valued customer, that International Window stands behind its products.

For more information regarding the International Window Lifetime Warranty, please contact your authorized International Window Dealer or visit our website at [www.intlwindow.com](http://www.intlwindow.com).

International Window appreciates your interest in our windows and doors and will continue to make strides to provide you with the highest quality and value.



